

**print
shop**

ПОСТАВЩИК РАСХОДНЫХ
МАТЕРИАЛОВ ДЛЯ ПОЛИГРАФИИ

ПРЕДСТАВЛЯЕТ

2008

Фурнитура и аксессуары для папок

Кольцевые механизмы
Арочные механизмы
Планшетные механизмы
Элементы крепления

‘08









print-shop.ru

Условные обозначения

1 | 2 | 3 | 4 | 5
PR 123-2-25/17

- 1 – тип механизма, O- (R), D- и Q-образный
- 2 – длина основания механизма, мм
- 3 – количество колец
- 4 – внутренний диаметр кольца, мм
- 5 – ширина основания механизма, мм

	расстояние между кольцами, мм		высота механизма, мм
	толщина подшиваемого материала, мм		количество в упаковке, шт
	ширина механизма, мм		вес упаковки, кг
	расстояние между крепежными отверстиями, мм		

Перфорация вложений



O-ОБРАЗНЫЕ			D- И Q-ОБРАЗНЫЕ		
13	4,0	4,0	10	4,0	4,0
15	4,0	4,0	15	6,5	4,5
16	4,0	4,0	20	6,5	4,5
19	4,0	4,0	30	6,5	4,5
20	6,5	4,5	35	6,5	5,5
25	6,5	4,5	35	6,5	5,5
26	6,5	4,5	35	6,5	5,5
30	6,5	5,5	50	6,5	5,5
32	6,5	5,5	52	6,5	5,5
35	6,5	5,5	55	7,5	6,5
38	6,5	5,5	65	7,5	7,5
45	6,5	5,5	75	7,5	7,5
48	6,5	5,5			
50	6,5	5,5			
53	6,5	5,5			
60	7,5	7,5			
70	7,5	7,5			

О-образные механизмы



2× КОЛЬЦЕВЫЕ

	PR123-2-13/17	80	8,5	16,7	17	115	500	10,7
*	PR123-2-16/17	80	11	20,8	20,7	115	500	11,2
	PR123-2-25/17	80	19,8	29,6	30,8	115	500	13,8
	PR110-2-16/20	80	11	20,8	20,7	101,4		
	PR110-2-19/20	80	14,2	24,8	23,3	101,4	500	12,3
	PR110-2-23/20	80	17,5	27,8	28,5	101,4		
	PR110-2-25/20	80	19,8	29,8	31	101,4	500	13,9
	PR110-2-27/20	80	21,6	32	32,8	101,4		
	PR110-2-30/20	80	24,6	35	35	101,4		
	PR110-2-25/20	52,5	19,8	29,8	31	101,4	500	13,9
	PR123-2-16/20	80	11	20,8	20,9	115	500	13,4
*	PR123-2-19/20	80	14,2	24,8	23,3	115	500	13,7
	PR123-2-23/20	80	17,5	27,8	28,5	115	500	15,1
*	PR123-2-25/20	80	19,8	29,8	31	115	500	15,3
	PR123-2-27/20	80	21,6	32	32,8	115	500	15,5
	PR123-2-30/20	80	24,6	35	35	115	500	15,8
	PR133-2-16/20	80	11	20,8	20,9	122	500	13,6
	PR133-2-19/20	80	14,2	24,8	23,3	122	500	13,7
	PR133-2-23/20	80	17,5	27,8	28,5	122	500	15,1
	PR133-2-25/20	80	19,8	29,8	31	122	500	15,3
	PR133-2-27/20	80	21,6	32	32,8	122	500	16,6
	PR133-2-30/20	80	24,6	35	35	122	500	17,2
	PR133-2-30/20	103	24,6	35	35	122	500	17,2
	PR123-2-27/26	80	22	32,2	32,6	115	400	16,2
	PR123-2-30/26	80	24,5	35	36	115	400	16,8
	PR123-2-32/26	80	27,6	37,6	39	115	400	18,2
	PR123-2-35/26	80	29	41	40,5	115	400	17,2
	PR123-2-38/26	80	32,5	43,2	43,9	115	400	18,9
	PR123-2-45/26	80	38,5	51	52	115	320	10,1
	PR123-2-50/26	80	44	56	57,6	115	240	16,01
	PR133-2-27/26	80	22	32,2	32,6	122	400	16,5
	PR133-2-30/26	80	24,5	35	36	122	400	17,3
	PR133-2-32/26	80	27,6	37,6	39	122	400	18,32
	PR133-2-35/26	80	29	41	40,5	122	400	17,12
	PR133-2-38/26	80	32,5	43,2	43,9	122	400	18,92
	PR133-2-45/26	80	38,5	51	52	122	320	10,3



* Наличие на складе в Москве



PR133-2-50/26	80	44	56	57,6	122	240	16,01
PR133-2-40/36	80	30	46,4	48,5	122		
PR133-2-51/36	80	42	57,4	57,7	122	180	16,2

3x КОЛЬЦЕВЫЕ

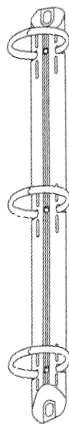

PR210-3-13/17	70 x 70	8,5	16,7	17	200	300	10
PR263-3-25-17	108 x 108	19,8	29,6	30,8	253		
PR280-3-13/17	108 x 108	8,5	16,7	17	270	300	15,8
PR280-3-25/17	108 x 108	19,8	29,6	30,8	270	250	15,1
PR210-3-16/20	70 x 70	11	20,8	20,7	200	300	13,11
PR210-3-19/20	70 x 70	14,2	24,8	23,3	200	300	14
PR210-3-23/20	70 x 70	17,5	27,8	28,5	200	300	14,4
PR210-3-25/20	70 x 70	19,8	29,8	31	200	300	14,91
PR210-3-27/20	70 x 70	21,6	32	32,8	200	300	14,9
PR210-3-30/20	70 x 70	24,6	35	35	200	250	14,5
PR241-3-16/20	89 x 89	11	20,8	20,7	231	300	18
PR241-3-19/20	89 x 89	14,2	24,8	23,3	231	300	18,9
PR241-3-23/20	89 x 89	17,5	27,8	28,5	231	300	
PR241-3-25/20	89 x 89	19,8	29,8	31	231	300	22
PR241-3-27/20	89 x 89	21,6	32	32,8	231	300	22
PR241-3-30/20	89 x 89	24,6	35	35	231	250	15,4
PR241-3-35/20	95 x 95	29	41	40,5	231		
PR241-3-38/20	95 x 95	31,2	41,6	42	231	250	16,4
PR263-3-20/20	108 x 108	14,2	24,8	23,3	253	300	17,31
PR263-3-25/20	108 x 108	19,8	29,8	31	253	250	15,63
PR263-3-30/20	108 x 108	24,6	35	35	253	250	15,3
PR263-3-38/20	108 x 108	31,2	41,6	42	253	250	16
PR280-3-16/20	108 x 108	11	20,8	20,7	270	300	17,91
PR280-3-19/20	108 x 108	14,2	24,8	23,3	270	300	18,09
PR280-3-23/20	108 x 108	17,5	27,8	28,5	270	300	
PR280-3-25/20	108 x 108	19,8	29,8	31	270	250	16
PR280-3-27/20	108 x 108	21,6	32	32,8	270	250	
PR280-3-30/20	108 x 108	24,6	35	35	270	250	17
PR210-3-27/26	70 x 70	22	32,2	32,6	200	200	13,1
PR210-3-30/26	70 x 70	24,5	35	36	200	200	13,9
PR210-3-32/26	70 x 70	27,6	37,6	39	200	200	13,9
PR210-3-35/26	70 x 70	29	41	40,5	200	200	14,3
PR210-3-38/26	70 x 70	32,5	43,2	43,9	200	200	15,6
PR210-3-45/26	70 x 70	38,5	51	52	200	160	19,01
PR210-3-50/26	70 x 70	44	56	57,6	200	120	15,8
PR241-3-27/26	89 x 89	22	32,2	32,6	231	200	16,1
PR241-3-30/26	89 x 89	24,5	35	36	231	200	18,2
PR241-3-32/26	89 x 89	27,6	37,6	39	231	200	18,2
PR241-3-35/26	89 x 89	29	41	40,5	231		
PR241-3-38/26	89 x 89	32,5	43,2	43,9	231	200	16,4
PR241-3-45/26	89 x 89	38,5	51	52	231		
PR241-3-50/26	89 x 89	44	56	57,6	231	160	17,9

* Наличие на складе в Москве



PR241-3-32/26	95 x 95	27,6	37,6	39	231	200	18,2
PR241-3-38/26	95 x 95	32,5	43,2	43,9	231	200	16,4
PR263-3-27/26	108 x 108	22	32,2	32,6	253	200	15,9
PR263-3-38/26	108 x 108	32,5	43,2	43,9	253	200	17
PR280-3-27/26	108 x 108	22	32,2	32,6	270	200	17,1
PR280-3-30/26	108 x 108	24,5	35	36	270	200	17,8
PR280-3-32/26	108 x 108	27,6	37,6	39	270	200	17,8
PR280-3-35/26	108 x 108	29	41	40,5	270	200	18
PR280-3-38/26	108 x 108	32,5	43,2	43,9	270	200	18
PR280-3-45/26	108 x 108	38,5	51	52	270	160	18,7
PR280-3-50/26	108 x 108	44	56	57,6	270	160	20,9
PR210-3-40/36	70 x 70	30	46,4	48,5	200		
PR210-3-51/36	70 x 70	42	57,4	57,7	200	120	19,5
PR241-3-40/36	89 x 89	30	46,4	48,5	231		
PR241-3-51/36	89 x 89	42	57,4	57,5	231	120	13,9
PR280-3-40/36	108 x 108	30	46,4	48,5	264,4	120	17,3
PR280-3-51/36	108 x 108	42	57,4	57,5	264,4	120	18,7
PR280-3-65/36	108 x 108	58	71,4	74	264,4	60	13,1
PR280-3-72/36	108 x 108	67	78,4	82	264,4	60	14

4x КОЛЬЦЕВЫЕ

PR280-4-15/15	80 x 80 x 80	11,2	18,2	18,9	270		
PR292-4-15/15	80 x 80 x 80	11,2	18,2	18,9	282		
PR210-4-13/17	45 x 65 x 45	8,5	16,7	17	200	300	10,2
PR210-4-16/17	45 x 65 x 45	11	20,8	20,7	200	300	13,2
* PR210-4-20/17	45 x 65 x 45	14,5	24,6	25	200	300	12,09
* PR280-4-16/17	80 x 80 x 80	11	20,8	20,7	270	300	
PR292-4-13/17	80 x 80 x 80	8,5	16,7	17	270	200	13,2
PR292-4-16/17	80 x 80 x 80	11	20,8	20,7	270	300	16,59
PR292-4-20/17	80 x 80 x 80	14,5	24,6	25	270	300	17,19
* PR292-4-25/17	80 x 80 x 80	19,8	29,6	30,8	270	250	15,6
PR292-4-30/17	80 x 80 x 80	24,6	35	34,5	270	250	16,9
PR152-4-16/20	21 x 70 x 21	11	20,8	20,9	144	500	18,2
PR152-4-20/20	21 x 70 x 21	14,2	24,8	23,3	144	500	19,4
PR152-4-23/20	21 x 70 x 21	17,5	27,8	28,58	144	400	17,7
PR152-4-25/20	21 x 70 x 21	19,8	29,8	31	144	400	17,72
PR152-4-27/20	21 x 70 x 21	21,6	32	32,8	144	400	17,7
PR152-4-30/20	21 x 70 x 21	24,6	35	35	144	500	21,6
PR210-4-16/20	45 x 65 x 45	11	20,8	20,9	200	300	15
PR210-4-18/20	45 x 65 x 45	12,6	21,2	21,6	200	300	14,8
PR210-4-19/20	45 x 65 x 45	14,2	24,8	23,3	200	300	14,82
PR210-4-23/20	45 x 65 x 45	17,5	27,8	28,5	200	300	16,8
PR210-4-25/20	45 x 65 x 45	19,8	29,8	31	200	300	16,8
PR210-4-27/20	45 x 65 x 45	21,6	32	32,8	200	300	16,8
PR210-4-30/20	45 x 65 x 45	24,6	35	35	200	250	14,9
PR237-4-30/20	80 x 35 x 80	24,6	35	35	225,5	300	19,2
PR280-4-16/20	80 x 80 x 80	11	20,8	20,7	270	300	17,91

* Наличие на складе в Москве

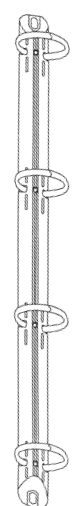
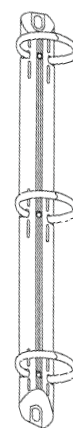



PR280-4-18/20	80 x 80 x 80	12,6	21,2	21,6	270	300	18,1
PR280-4-19/20	80 x 80 x 80	14,2	24,8	23,3	270	300	18,51
PR280-4-23/20	80 x 80 x 80	17,5	27,8	28,5	270	250	16
PR280-4-25/20	80 x 80 x 80	19,8	29,8	31	270	250	16
PR280-4-27/20	80 x 80 x 80	21,6	32	32,8	270	250	16
PR280-4-30/20	80 x 80 x 80	24,6	35	35	270	250	17
PR292-4-18/20	80 x 80 x 80	12,6	21,2	21,6	282	300	20,19
PR292-4-19/20	80 x 80 x 80	14,2	24,8	23,3	282	300	20,49
PR292-4-23/20	80 x 80 x 80	17,5	27,8	28,5	282	250	18,7
PR292-4-25/20	80 x 80 x 80	19,8	29,8	31	282	250	18,7
PR292-4-27/20	80 x 80 x 80	21,6	32	32,8	282	250	
PR292-4-30/20	80 x 80 x 80	24,6	35	35	282	250	18,9
PR152-4-27/26	21 x 70 x 21	22	32,2	32,6	144	400	22,1
PR152-4-30/26	21 x 70 x 21	24,5	35	36	144	400	22,32
PR152-4-32/26	21 x 70 x 21	27,6	37,6	39	144	400	23,8
PR152-4-35/26	21 x 70 x 21	29	41	40,5	144	400	25,32
PR152-4-38/26	21 x 70 x 21	32,5	43,2	43,9	144	400	25,32
PR152-4-45/26	21 x 70 x 21	38,5	51	52	144	320	22,4
PR152-4-50/26	21 x 70 x 21	44	56	57,6	144	240	17,9
PR210-4-27/26	45 x 65 x 45	22	32,2	32,6	200	200	
PR210-4-30/26	45 x 65 x 45	24,5	35	36	200	200	14,5
PR210-4-32/26	45 x 65 x 45	27,6	37,6	39	200	200	16
PR210-4-35/26	45 x 65 x 45	29	41	40,5	200	200	19
PR210-4-38/26	45 x 65 x 45	32,5	43,2	43,9	200	200	17
PR210-4-45/26	45 x 65 x 45	38,5	51	52	200	160	18,21
PR210-4-50/26	45 x 65 x 45	44	56	57,6	200	120	15,6
PR237-4-30/26	80 x 35 x 80	24,5	35	36	225,5	200	
PR241-4-30/26	80 x 35 x 80	24,5	35	36	231	200	
PR245-4-30/26	80 x 35 x 80	24,5	35	36	234,2	200	
PR263-4-27/26	80 x 56 x 80	22	32,2	32,6	253	200	14,7
PR280-4-27/26	80 x 80 x 80	22	32,2	32,6	270	200	
PR280-4-30/26	80 x 80 x 80	24,5	35	36	270	200	16
PR280-4-32/26	80 x 80 x 80	27,6	37,6	39	270	200	
PR280-4-35/26	80 x 80 x 80	29	41	40,5	270	200	17,4
PR280-4-38/26	80 x 80 x 80	32,5	43,2	43,9	270	200	18
PR280-4-45/26	80 x 80 x 80	38,5	51	52	270	160	
PR280-4-50/26	80 x 80 x 80	44	56	57,6	270	160	
PR292-4-27/26	80 x 80 x 80	22	32,2	32,6	282	200	18,1
PR292-4-30/26	80 x 80 x 80	24,5	35	36	282	200	20,2
PR292-4-32/26	80 x 80 x 80	27,6	37,6	39	282	200	20
PR292-4-35/26	80 x 80 x 80	29	41	40,5	282	200	21,1
PR292-4-38/26	80 x 80 x 80	32,5	43,2	43,9	282	200	22,1
PR292-4-45/26	80 x 80 x 80	38,5	51	52	282	160	24,4
PR292-4-50/26	80 x 80 x 80	44	56	57,6	282	160	23,5
PR292-4-51/26	80 x 80 x 80	42	57,4	57,5	289	120	21

* Наличие на складе в Москве

D-образные механизмы



2* КОЛЬЦЕВЫЕ

PD123-2-25/17	80	25	31	35,5	115	400	12
PD123-2-20/17	80	20	28,5	30,8	115	400	10,8
PD110-2-16/20	80	16	24,3	25,2	101,4	500	
PD110-2-20/20	80	20	28,5	30,8	101,4		
PD110-2-25/20	80	25	31	36	101,4	500	
PD110-2-30/20	80	30	35,5	42	101,4		
PD123-2-16/20	80	16	24,3	25,2	115	500	13,9
PD123-2-20/20	80	20	28,5	30,8	115	500	15,1
* PD123-2-25/20	80	25	31	36	115	500	15,7
PD123-2-30/20	80	30	35,5	42	115	400	13,6
PD133-2-16/20	80	16	24,3	25,2	122	500	13,7
PD133-2-20/20	80	20	28,5	30,8	122	500	15,4
PD133-2-25/20	80	25	31	36	122	500	16,2
PD133-2-30/20	80	30	35,5	42	122	500	17,5
PD123-2-25/26	80	25	31	36	115	400	
PD123-2-30/26	80	30	35,5	42	115	400	17,72
PD123-2-32/26	80	32	36,5	44,5	115	400	
* PD123-2-35/26	80	35	40	47	115	320	15,1
PD123-2-38/26	80	38	40	49,8	115	320	16
* PD123-2-40/26	80	40	43	52,5	115	320	15,7
PD123-2-45/26	80	45	45,5	57	115	320	18,9
PD123-2-50/26	80	50	48	62	115	240	16,8
PD123-2-55/26	80	55	42,6	65,5	115	240	
PD133-2-25/26	80	25	31	36	122	240	11,71
PD133-2-30/26	80	30	35,5	42	122	400	18,72
PD133-2-32/26	80	32	36,5	44,5	122	400	18,72
PD133-2-35/26	80	35	40	47	122	400	18,92
PD133-2-38/26	80	38	40	49,8	122	320	15,49
PD133-2-40/26	80	40	43	52,5	122	320	16
PD133-2-45/26	80	45	45,5	57	122	320	20,29
* PD133-2-50/26	80	50	48	62	122	240	16,9
* PD133-2-55/26	80	55	42,6	65,5	122	240	16,01
PD133-2-51/36	80	51	54,2	66,6	122	180	16,79
PD133-2-55/36	80	55	54,5	68	122	180	19,49
PD133-2-60/36	80	60	57	73	122	180	20,3

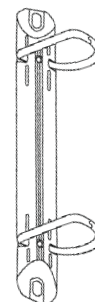

* Наличие на складе в Москве

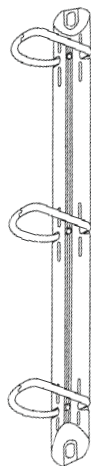

3x КОЛЬЦЕВЫЕ

PD210-3-25/17	70 x 70	25	31	36	200	300	14,01
PD210-3-16/20	70 x 70	16	24,3	25,2	200	300	16
PD210-3-20/20	70 x 70	20	28,5	30,8	200	300	16,59
PD210-3-25/20	70 x 70	25	31	36	200	250	12,9
PD210-3-30/20	70 x 70	30	35,5	42	200	250	13,6
PD241-3-16/20	89 x 89	16	24,3	25,2	231	300	16
PD241-3-20/20	89 x 89	20	28,5	30,8	231	250	14,5
PD241-3-25/20	89 x 89	25	31	36	231	250	17,5
PD241-3-30/20	89 x 89	30	35,5	42	231		
PD263-3-25/20	108 x 108	25	31	36	253	250	16,2
PD263-3-30/20	108 x 108	30	35,5	42	253	250	17,7
PD263-3-32/20	108 x 108	32	36	44,3	253	250	
PD263-3-38/20	108 x 108	38	38,5	48,6	253	250	
PD280-3-16/20	108 x 108	16	24,3	25,2	270	300	18
PD280-3-20/20	108 x 108	20	28,5	30,8	270	250	15,4
PD280-3-25/20	108 x 108	25	31	36	270	250	16,8
PD280-3-30/20	108 x 108	30	35,5	42	270	200	17,2
PD210-3-25/26	70 x 70	25	31	36	200	240	16,7
PD210-3-30/26	70 x 70	30	35,5	42	200	200	13,5
PD210-3-32/26	70 x 70	32	36,5	44,5	200	200	13,5
PD210-3-35/26	70 x 70	35	40	47	200	200	14,7
PD210-3-38/26	70 x 70	38	40	49,8	200	200	10
PD210-3-40/26	70 x 70	40	43	52,5	200	200	15,3
PD210-3-45/26	70 x 70	45	45,5	57	200	160	20,61
PD210-3-50/26	70 x 70	50	48	62	200	120	13,1
PD210-3-55/26	70 x 70	55	42,6	65,5	200	160	
PD220-3-38/26(2E)	89 x 89	38	40	49,8	120	200	17,5
PD241-3-25/26	89 x 89	25	31	36	231	200	15,5
PD241-3-30/26	89 x 89	30	35,5	42	231	200	17
PD241-3-32/26	89 x 89	32	36,5	44,5	231	200	16,3
PD241-3-35/26	89 x 89	35	40	47	231	160	13,1
* PD241-3-38/26	89 x 89	38	40	49,8	231	160	14,1
PD241-3-40/26	89 x 89	40	43	52,5	231	160	14,3
PD241-3-45/26	89 x 89	45	45,5	57	231	120	19,5
PD241-3-50/26	89 x 89	50	48	62	231	120	14,3
* PD241-3-55/26	89 x 89	55	42,6	65,5	231	120	14,9
PD263-3-25/26	108 x 108	25	31	36	253	180	16,78
PD263-3-30/26	108 x 108	30	35,5	42	253	200	17,2
PD263-3-32/26	108 x 108	32	36,5	44,5	253	160	14,21
PD263-3-35/26	108 x 108	35	40	47	253	160	13,9
PD263-3-38/26	108 x 108	38	40	49,8	253	160	15,1
PD263-3-50/26	108 x 108	50	48	62	253	120	15,9
PD280-3-25/26	108 x 108	25	31	36	270	200	17,2
PD280-3-30/26	108 x 108	30	35,5	42	270	160	14,9
PD280-3-32/26	108 x 108	32	36,5	44,5	270	160	14,9

* Наличие на складе в Москве



	PD280-3-35/26	108 x 108	35	40	47	270	160	15,41
	PD280-3-38/26	108 x 108	38	40	49,8	270	160	15,9
*	PD280-3-40/26	108 x 108	40	43	52,5	270	160	15,9
	PD280-3-45/26	108 x 108	45	45,5	57	270	120	15,5
	PD280-3-50/26	108 x 108	50	48	62	270	120	16,1
	PD280-3-55/26	108 x 108	55	42,6	65,5	270	120	20
	PD210-3-51/26	70 x 70	51	54,2	66,6	200	90	13,6
	PD280-3-40/36	108 x 108	40	44,2	52	264,4	120	12,2
	PD280-3-51/36	108 x 108	51	54,2	66,6	264,4	90	15,7
*	PD280-3-55/36	108 x 108	55	54,5	68	264,4	90	18,3
	PD280-3-60/36	108 x 108	60	57	73	264,4	90	19,3
	PD280-3-65/36	108 x 108	65	60	78,4	264,4	90	19,5
4x КОЛЬЦЕВЫЕ								
	PD292-4-16/17	80 x 80 x 80	16	24,3	25	282	300	17,3
	PD292-4-20/17	80 x 80 x 80	20	28,5	30,8	282	300	18,9
	PD292-4-25/17	80 x 80 x 80	25	31	35,5	282	300	19,6
	PD152-4-16/20	21 x 70 x 21	16	24,3	25,2	144	500	18,1
	PD152-4-20/20	21 x 70 x 21	20	28,5	30,8	144	500	19,6
	PD152-4-25/20	21 x 70 x 21	25	31	36	144	500	21,1
	PD152-4-30/20	21 x 70 x 21	30	35,5	42	144	400	18,3
	PD210-4-16/20	45 x 65 x 45	16	24,3	25,2	200	300	16,41
	PD210-4-20/20	45 x 65 x 45	20	28,5	30,8	200	300	16,59
	PD210-4-25/20	45 x 65 x 45	25	31	36	200	250	15,2
	PD210-4-27/20	45 x 65 x 45	27	31	37,6	200	300	18,21
	PD210-4-30/20	45 x 65 x 45	30	35,5	42	200	250	15,9
	PD280-4-16/20	80 x 80 x 80	16	24,3	25,2	270	300	18
	PD280-4-16/17	80 x 80 x 80	16	24,3	25	270	300	16,8
	PD280-4-20/17	80 x 80 x 80	20	28,5	30,8	270	300	18,9
	PD280-4-25/17	80 x 80 x 80	25	31	35,5	270	300	19,59
	PD280-4-20/20	80 x 80 x 80	20	28,5	30,8	270	250	15,6
	PD280-4-25/20	80 x 80 x 80	25	31	36	270	250	17
	PD280-4-27/20	80 x 80 x 80	27	31	37,6	270	250	17,8
	PD280-4-30/20	80 x 80 x 80	30	35,5	42	270	250	18,5
	PD292-4-16/20	80 x 80 x 80	16	24,3	25,2	282	250	17,4
	PD292-4-20/20	80 x 80 x 80	20	28,5	30,8	282	250	18,1
*	PD292-4-25/20	80 x 80 x 80	25	31	36	282	250	19,7
	PD292-4-27/20	80 x 80 x 80	27	31	37,6	282	250	19,7
	PD292-4-30/20	80 x 80 x 80	30	35,5	42	282	250	19,7
	PD152-4-25/26	21 x 70 x 21	25	31	36	144	400	19,9
	PD152-4-30/26	21 x 70 x 21	30	35,5	42	144	400	21,5
	PD152-4-32/26	21 x 70 x 21	32	36,5	44,5	144	400	22,3
	PD152-4-35/26	21 x 70 x 21	35	40	47	144	400	23,1
	PD152-4-38/26	21 x 70 x 21	38	40	49,8	144	320	20
	PD152-4-40/26	21 x 70 x 21	40	43	52,5	144	320	20
	PD152-4-45/26	21 x 70 x 21	45	45,5	57	144	320	21,7



* Наличие на складе в Москве



PD152-4-50/26	21 x 70 x 21	50	48	62	144	240	19,1
PD152-4-55/26	21 x 70 x 21	55	42,6	65,5	144		
PD210-4-25/26	45 x 65 x 45	25	31	36	200	240	18,19
PD210-4-30/26	45 x 65 x 45	30	35,5	42	200	200	16,2
PD210-4-32/26	45 x 65 x 45	32	36,5	44,5	200	200	18,5
PD210-4-35/26	45 x 65 x 45	35	40	47	200	200	16,6
PD210-4-38/26	45 x 65 x 45	38	40	49,8	200	200	17,2
PD210-4-40/26	45 x 65 x 45	40	43	52,5	200	200	17,2
PD210-4-45/26	45 x 65 x 45	45	45,5	57	200	160	18,7
PD210-4-50/26	45 x 65 x 45	50	48	62	200	160	15,81
PD210-4-55/26	45 x 65 x 45	55	42,6	65,5	200		
PD280-4-25/26	80 x 80 x 80	25	31	36	270		
PD280-4-30/26	80 x 80 x 80	30	35,5	42	270	200	18,2
PD280-4-32/26	80 x 80 x 80	32	36,5	44,5	270	160	15
PD280-4-35/26	80 x 80 x 80	35	40	47	270	160	15,41
PD280-4-38/26	80 x 80 x 80	38	40	49,8	270	160	15,9
PD280-4-40/26	80 x 80 x 80	40	43	52,5	270	160	15,9
PD280-4-45/26	80 x 80 x 80	45	45,5	57	270	120	15,5
PD280-4-50/26	80 x 80 x 80	50	48	62	270	120	18,5
PD280-4-55/26	80 x 80 x 80	55	42,6	65,5	270		
PD292-4-25/26	80 x 80 x 80	25	31	36	282	200	20,1
PD292-4-30/26	80 x 80 x 80	30	35,5	42	282	200	21,3
PD292-4-32/26	80 x 80 x 80	32	40	47	282	160	17,7
* PD292-4-35/26	80 x 80 x 80	35	40	47	282	160	18,1
PD292-4-38/26	80 x 80 x 80	38	40	47	282	160	18,5
* PD292-4-40/26	80 x 80 x 80	40	43	52,5	282	160	19,2
PD292-4-45/26	80 x 80 x 80	45	45,5	57	282	160	23,3
* PD292-4-50/26	80 x 80 x 80	50	48	62	282	120	19,2
* PD292-4-55/26	80 x 80 x 80	55	42,6	65,5	282	120	19
PD210-4-55/36	45 x 65 x 45	55	54,5	68	200	90	15
PD210-4-60/36	45 x 65 x 45	60	57	73	200	90	16,9
PD280-4-65/36	80 x 80 x 80	65	60	78,4	270	90	19,5
PD299-4-55/36	80 x 80 x 80	55	54,5	68	289	90	22,1
PD299-4-60/36	80 x 80 x 80	60	57	73	289	90	23
PD299-4-65/36	80 x 80 x 80	65	60	78,4	289	90	23,4

* Наличие на складе в Москве

Q-образные механизмы



2× КОЛЬЦЕВЫЕ

PQ110-2-18/20	50	18	25,5	28,3	101,4	500	13,9
PQ110-2-20/20	80	20	24,8	28,6	101,4	500	13,9
PQ110-2-25/20	80	25	25,3	33,7	101,4		
PQ110-2-30/20	80	30	30	42	101,4	400	
PQ110-2-35/20	80	35	25	43,5	101,4		
PQ123-2-18/20	80	18	25,5	28,3	115	500	13
PQ123-2-20/20	80	20	24,8	28,6	115	500	14,6
PQ123-2-25/20	80	25	25,3	33,7	115	500	15,8
PQ123-2-30/20	80	30	30	42	115	500	16,7
PQ123-2-35/20	80	35	25	43,5	115	500	
PQ133-2-20/20	80	20	24,8	28,6	122	500	18
PQ133-2-25/20	80	25	25,3	33,7	122	500	20
PQ133-2-30/20	80	30	30	42	122	500	17,2
PQ133-2-35/20	80	35	25	43,5	122	500	18,3
PQ133-2-35/20	90	35	25	43,5	122	500	18,3
PQ123-2-30/26	80	30	30	42	115	400	
PQ123-2-35/26	80	35	33	47	115	320	
PQ123-2-40/26	80	40	34	52,5	115	320	
PQ123-2-45/26	80	45	34	57	115	320	
PQ123-2-50/26	80	50	35	62	115	240	
PQ133-2-30/26	80	30	30	42	122	400	18,72
PQ133-2-35/26	80	35	33	47	122	320	
PQ133-2-40/26	80	40	34	52,5	122	320	15,2
PQ133-2-45/26	80	45	34	57	122	320	20,29
PQ133-2-50/26	80	50	35	62	122	240	16,51
PQ133-2-55/36	80	55	42	71	122	180	21,1
PQ133-2-60/36	80	60	42	76,5	122	180	20,5
* PQ133-2-65/36	80	65	42	81	122	180	21,4
PQ133-2-80/36	80	80	38,8	96	122		

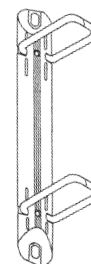

3× КОЛЬЦЕВЫЕ

PQ210-3-20/20	70 x 70	20	24,8	28,6	200	250	
PQ210-3-25/20	70 x 70	25	25,3	33,7	200	250	
PQ210-3-30/20	70 x 70	30	30	42	200	250	
PQ210-3-35/20	70 x 70	35	25	43,5	200	250	
PQ241-3-20/20	89 x 89	20	24,8	28,6	231	250	

* Наличие на складе в Москве

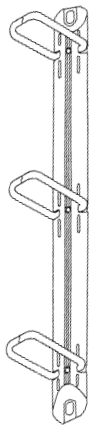

PQ241-3-25/20	89 x 89	25	25,3	33,7	231	250	
PQ241-3-30/20	89 x 89	30	30	42	231	250	
PQ241-3-35/20	89 x 89	35	25	43,5	231		
PQ280-3-20/20	108 x 108	20	24,8	28,6	270	250	16,4
PQ280-3-25/20	108 x 108	25	25,3	33,7	270	250	18,4
PQ280-3-30/20	108 x 108	30	30	42	270	250	
PQ280-3-35/20	108 x 108	35	25	43,5	270	250	22,7
PQ210-3-30/26	70 x 70	30	30	42	200	200	
PQ210-3-35/26	70 x 70	35	33	47	200	200	
PQ210-3-40/26	70 x 70	40	34	52,5	200	200	
PQ210-3-45/26	70 x 70	45	34	57	200	120	
PQ210-3-50/26	70 x 70	50	35	62	200	120	
PQ210-3-65/26	70 x 70	65	35,8	77,8	200		
PQ241-3-30/26	89 x 89	30	30	42	231	200	
PQ241-3-35/26	89 x 89	35	33	47	231		
PQ241-3-40/26	89 x 89	40	34	52,5	231	160	
PQ241-3-45/26	89 x 89	45	34	57	231	160	
PQ241-3-50/26	89 x 89	50	35	62	231	120	
PQ263-3-30/26	108 x 108	30	30	42	253	100	9,3
PQ263-3-45/26	108 x 108	45	34	57	253	80	10,2
PQ280-3-30/26	108 x 108	30	30	42	270	200	20,5
PQ280-3-35/26	108 x 108	35	33	47	270	200	23,8
PQ280-3-40/26	108 x 108	40	34	52,5	270	160	15,5
PQ280-3-45/26	108 x 108	45	34	57	270	160	20,8
PQ280-3-50/26	108 x 108	50	35	62	270	120	16
PQ280-3-55/36	108 x 108	55	42	71	264,4	90	19,8
PQ280-3-60/36	108 x 108	60	42	76,5	264,4	90	20
PQ280-3-65/36	108 x 108	65	42	81	264,4	90	20,4
PQ280-3-80/36	108 x 108	80	38,8	96	264,4		
4x КОЛЬЦЕВЫЕ							
PQ292-4-25/17	80 x 80 x 80	25	25,3	33,7	282	250	15,9
PQ152-4-20/20	21 x 70 x 21	20	24,8	28,6	144	500	19,6
PQ152-4-25/20	21 x 70 x 21	25	25,3	33,7	144	500	21,1
PQ152-4-30/20	21 x 70 x 21	30	30	42	144	400	18,3
PQ152-4-35/20	21 x 70 x 21	35	25	43,5	144		
PQ205-4-20/20	45 x 65 x 45	20	24,8	28,6	196,5	300	17,01
PQ210-4-20/20	45 x 65 x 45	20	24,8	28,6	200	250	17,7
PQ210-4-25/20	45 x 65 x 45	25	25,3	33,7	200	250	15,2
PQ210-4-30/20	45 x 65 x 45	30	30	42	200	250	16,6
PQ210-4-35/20	45 x 65 x 45	35	25	43,5	200		
PQ280-4-20/20	80 x 80 x 80	20	24,8	28,6	270	250	
PQ280-4-25/20	80 x 80 x 80	25	25,3	33,7	270	250	
PQ280-4-30/20	80 x 80 x 80	30	30	42	270	250	16,4
PQ280-4-35/20	80 x 80 x 80	35	25	43,5	270	250	19,5
PQ280-4-35/20	76,2 x 88,9 x 76,5	35	25	43,5	270	250	
PQ280-4-52/20	76,2 x 88,9 x 76,2	52	24,5	63,5	270	150	14

* Наличие на складе в Москве



PQ292-4-20/20	80 x 80 x 80	20	24,8	28,6	282	250	19
PQ292-4-25/20	80 x 80 x 80	25	25,3	33,7	282	250	20,2
PQ292-4-30/20	80 x 80 x 80	30	30	42	282	250	20,8
PQ292-4-35/20	80 x 80 x 80	35	25	43,5	282	200	
PQ152-4-30/26	21 x 70 x 21	30	30	42	144	400	21,5
PQ152-4-35/26	21 x 70 x 21	35	33	47	144	400	23,1
PQ152-4-40/26	21 x 70 x 21	40	34	52,5	144		
PQ152-4-45/26	21 x 70 x 21	45	34	57	144	320	21,7
PQ152-4-50/26	21 x 70 x 21	50	35	62	144	240	19,1
PQ210-4-30/26	45 x 65 x 45	30	30	42	200	200	16,2
PQ210-4-35/26	45 x 65 x 45	35	33	47	200	200	21,7
PQ210-4-40/26	45 x 65 x 45	40	34	52,5	200	200	22,6
PQ210-4-45/26	45 x 65 x 45	45	34	57	200	120	14,5
PQ210-4-50/26	45 x 65 x 45	50	35	62	200	120	15,1
PQ280-4-35/26	80 x 80 x 80	35	33	47	270	200	
PQ280-4-30/26	80 x 80 x 80	30	30	42	270	200	
PQ280-4-40/26	80 x 80 x 80	40	34	52,5	270	160	
PQ280-4-45/26	80 x 80 x 80	45	34	57	270	160	
PQ280-4-50/26	80 x 80 x 80	50	35	62	270	120	
PQ292-4-30/26	80 x 80 x 80	30	30	42	282	160	17,7
PQ292-4-35/26	80 x 80 x 80	35	33	47	282	160	18,1
PQ292-4-40/26	80 x 80 x 80	40	34	52,5	282	160	18,5
PQ292-4-45/26	80 x 80 x 80	45	34	57	282	160	23,3
PQ292-4-50/26	80 x 80 x 80	50	35	62	282	120	19,2
PQ210-4-55/36	45 x 65 x 45	55	42	71	200	90	14
PQ210-4-60/36	45 x 65 x 45	60	42	76,5	200	90	15,8
PQ299-4-55/36	80 x 80 x 80	55	42	71	289	90	23,5
PQ299-4-60/36	80 x 80 x 80	60	42	76,5	289	90	21
PQ299-4-65/36	80 x 80 x 80	65	42	81	289	90	22,3
PQ299-4-80/36	80 x 80 x 80	80	38,8	96	289		

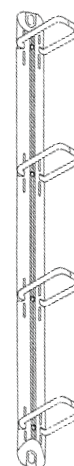

Элементы крепления



АРТ	А	В	С
* 4,0 x 7,0 x 6,6	∅ 7,0	∅ 4,0	6,6
* 3,8 x 8,0 x 8,0	∅ 8,0	∅ 3,8	8,0
* 3,7 x 6,8 x 6,0	∅ 6,8	∅ 3,7	6,0
* 4,0 x 6,0 x 7,0	∅ 7,0	∅ 4,0	6,0

НИКЕЛЬ

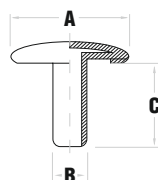

* Наличие на складе в Москве

Рычажные механизмы



LAM50	200	16,3
LAM75	200	18,8
LAM80	50	5,9
ПРИЖИМ	1 000	14,1
САЛАЗКИ	1 000	17,5

РАЗМЕРЫ, мм	H	L	S	T
LAM50	50	80	85	25
LAM75	74	80	88	32
LAM80	79	80	92	32

ПОЛОЖЕНИЕ КРЕПЕЖНЫХ ОТВЕРСТИЙ, мм

Вариант	A	E	F	M
a	94	94	94	94
b	55	55	55	55
c	53	54,1	53	53
d	83,5	83,5	85,5	86
e	31,5	32	32	32
f	4	4	4,3	4,0

ДИАМЕТР КРЕПЕЖНЫХ ОТВЕРСТИЙ, мм

Вариант	1	2	3	4	5
g	3,5	3,8	4,2	4,5	4,7

ПОЛОЖЕНИЕ ОТВЕРСТИЙ САЛАЗОК, мм

Вариант	A	E	F	M
c	53	54,1	53	53
d	83,5	83,5	85,5	86
e	31,5	32	32	32
f	4	4	4,3	4,0

ДИАМЕТР ОТВЕРСТИЙ САЛАЗОК, мм

g	3,5	3,8	4,2	4,5	4,7
---	-----	-----	-----	-----	-----

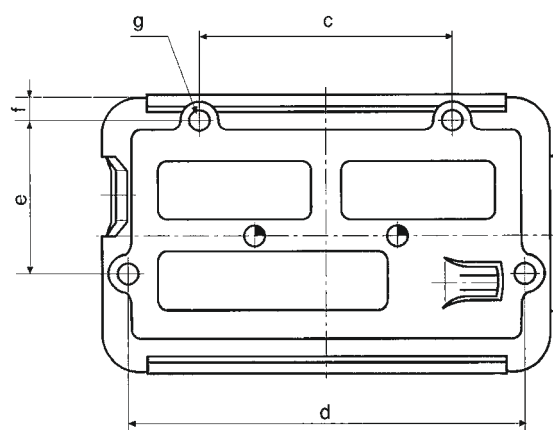
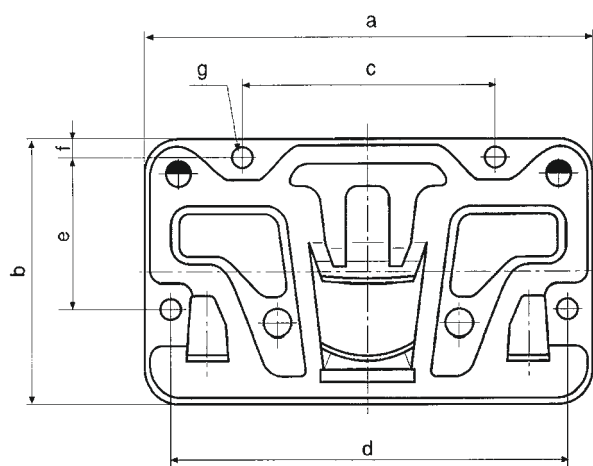
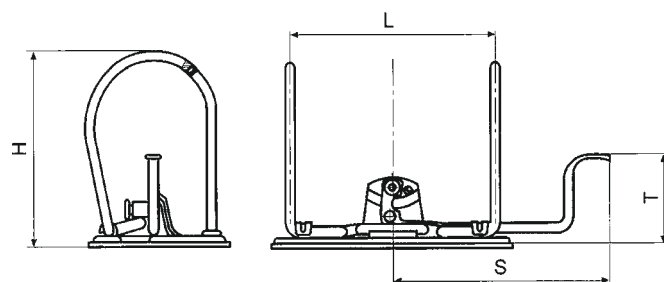

* Наличие на складе в Москве

Аксессуары для рычажных механизмов и папок



ПРИЖИМ ДЛЯ БУМАГИ	1 000
КОЛЬЦО 120/20 КОРЕШКОВОЕ	10 000
КОЛЬЦО 120/24 СТОПОРНОЕ	10 000
* ДЕРЖАТЕЛЬ 1070ТР ДЛЯ CD ПРОЗРАЧНЫЙ	1 000
* ДЕРЖАТЕЛЬ 1080 ДЛЯ CD БЕЛЫЙ/ЧЕРНЫЙ	1 000
* ДЕРЖАТЕЛЬ 1020R ДЛЯ РУЧКИ НА ЛИПУЧКЕ	1 000
* ДЕРЖАТЕЛЬ 1020 ДЛЯ РУЧКИ	1 000
* РУЧКА ПЛАСТИКОВАЯ ДЛЯ ПОРТФЕЛЯ	1 000
* ЗАМОК ПЛАСТИКОВЫЙ SILVIA 2000/2,5	1 000
* ЗАМОК ПЛАСТИКОВЫЙ ELEGANT 2,5	1 000



Планшетные механизмы



JN123 С РЫЧАГОМ	1000	12,9
JN124 С РЫЧАГОМ	2000	54,3
JN125 ПРОВОЛОЧНЫЙ ПРИЖИМ	800	8
JN126/100 ПЛОСКИЙ	800	19,2
JN126/120 ПЛОСКИЙ	1000	28,4



* Наличие на складе в Москве

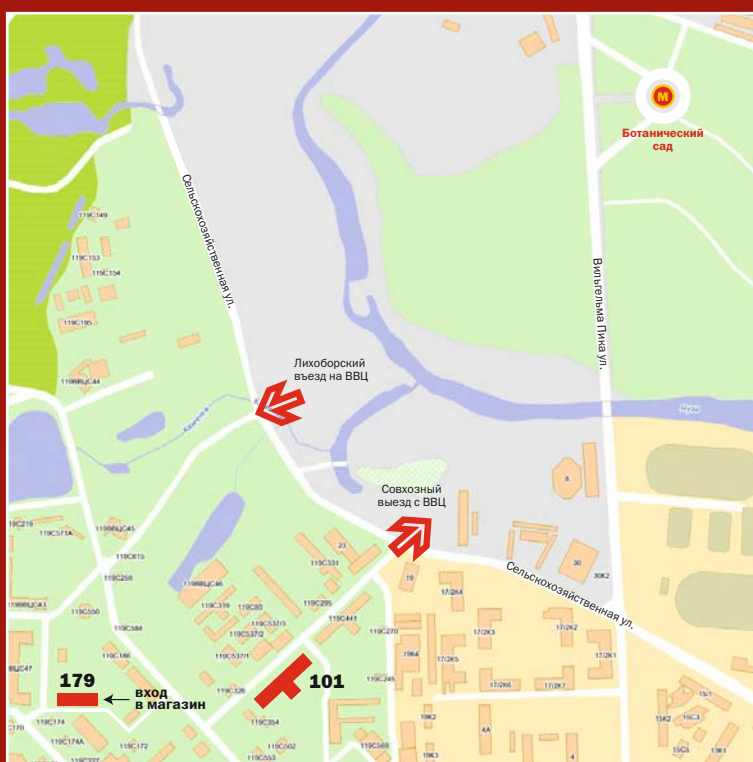

© 2008 **Print Space**

Москва, проспект Мира, ВВЦ
павильон 101, офис 12

print-shop.ru

printspace.ru
printmagnet.ru
kvartalnik.ru
binders.ru
printmailer.ru

(495) **784-79-99**

**Магазин
мелкооптовой
и розничной
торговли**

Москва, пр-т Мира
ВВЦ, пав. 179

с 1.09.2007
9:00—21:00
с понедельника
по субботу

(495) **788-31-66**